

A regular pentagon is inscribed in circle O .
Find the $m\angle ABC$.

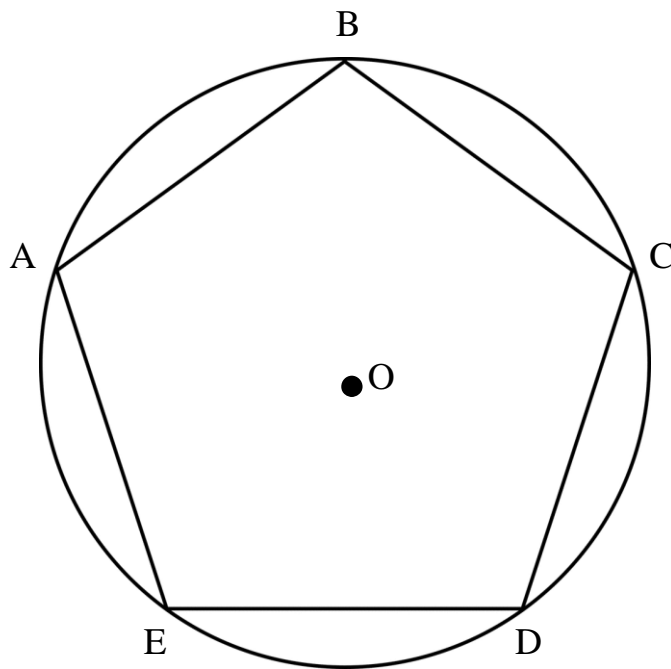

9

Find x

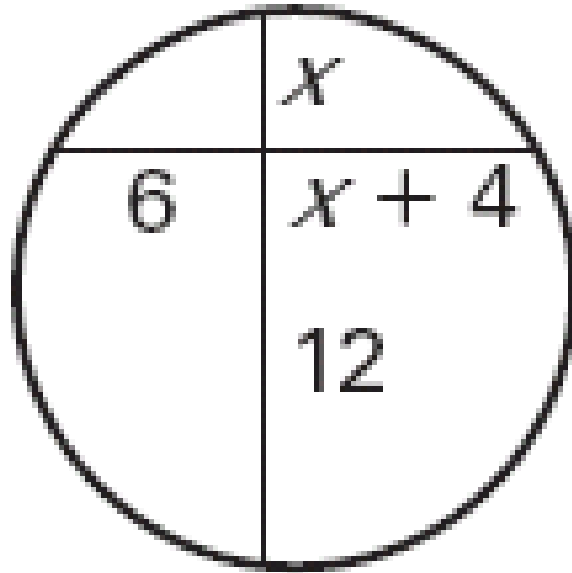

108

Find x

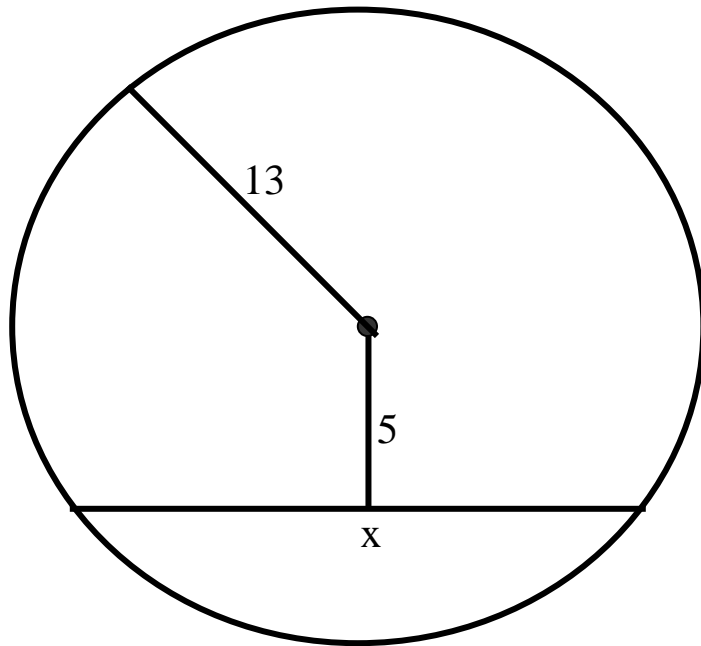

4

Find x

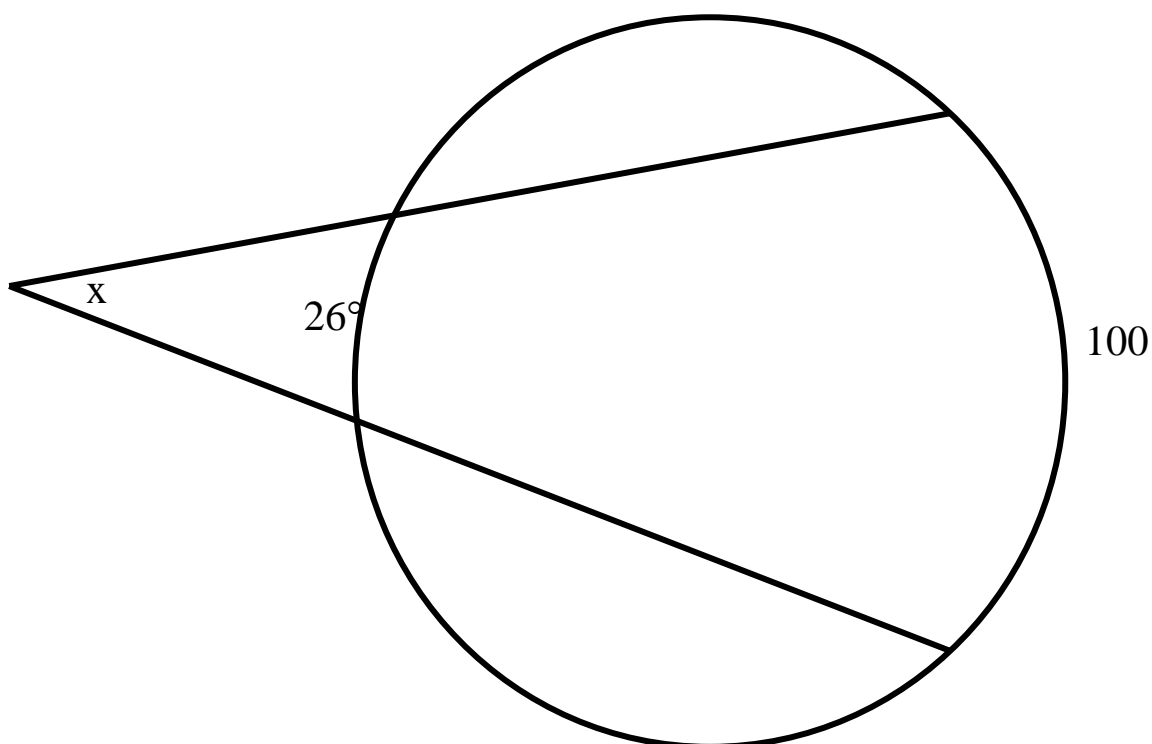

24

Find x

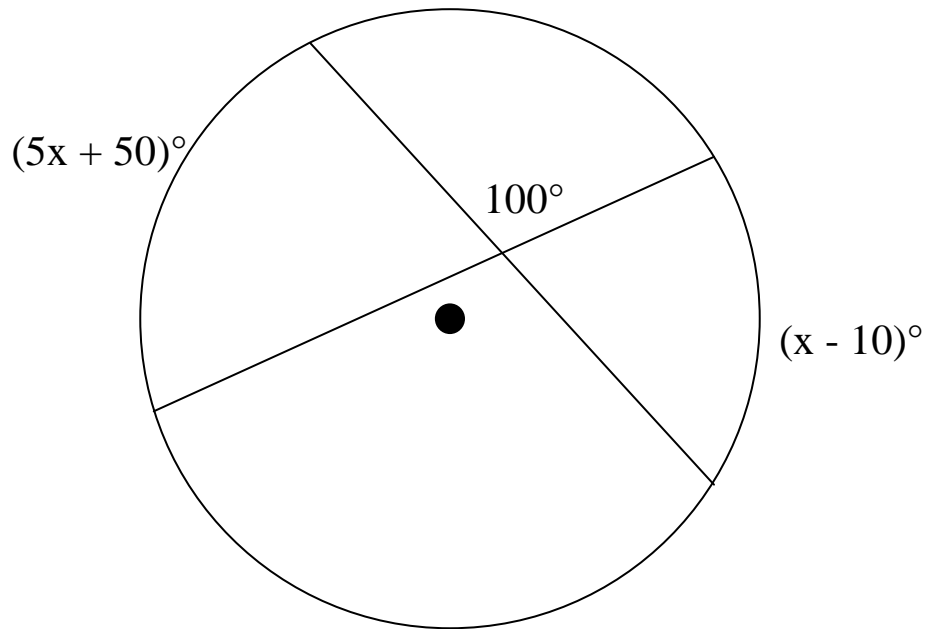

37

Find x

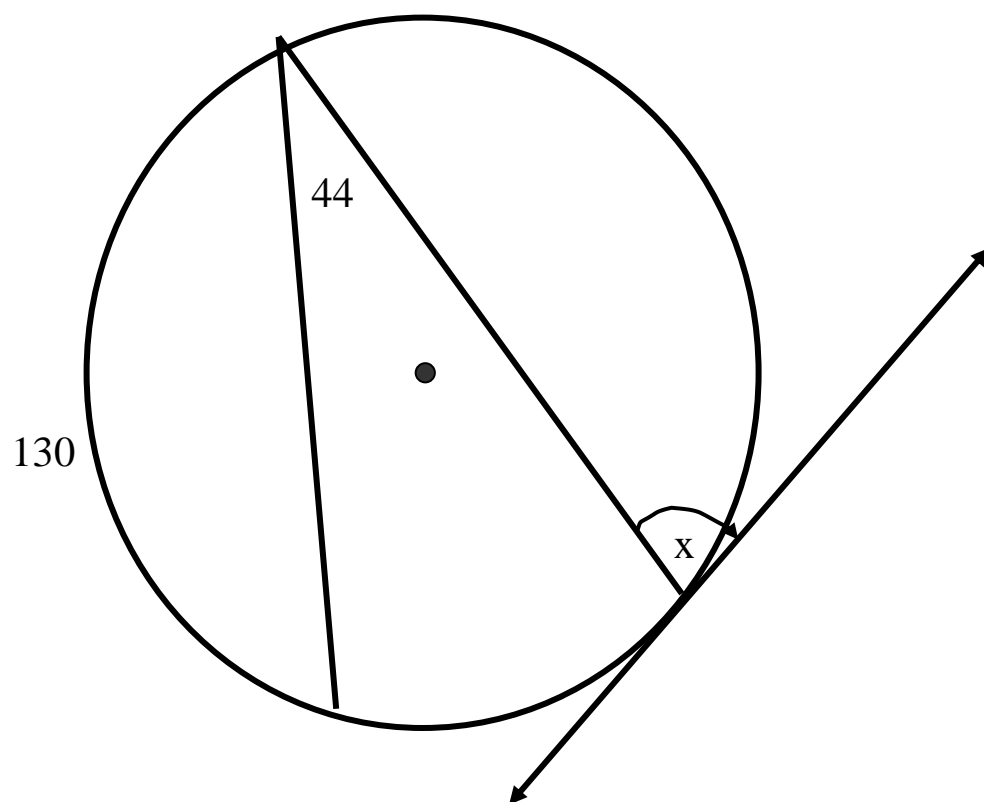

20

Find x

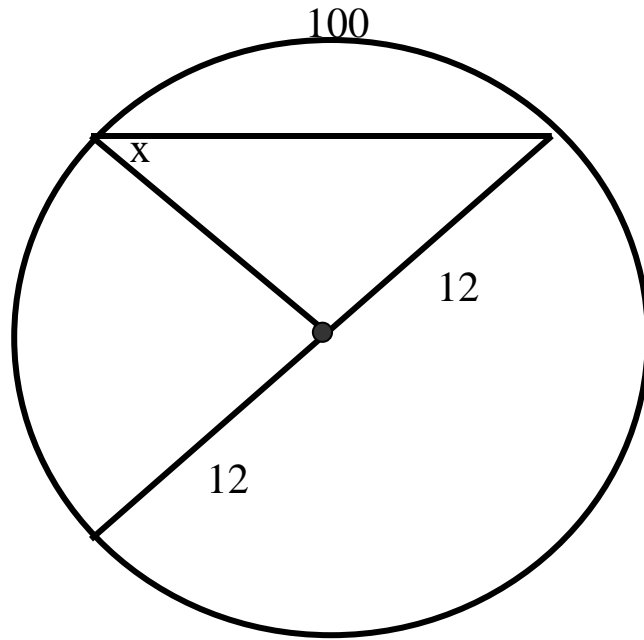

71

Find the perimeter of the following shape.

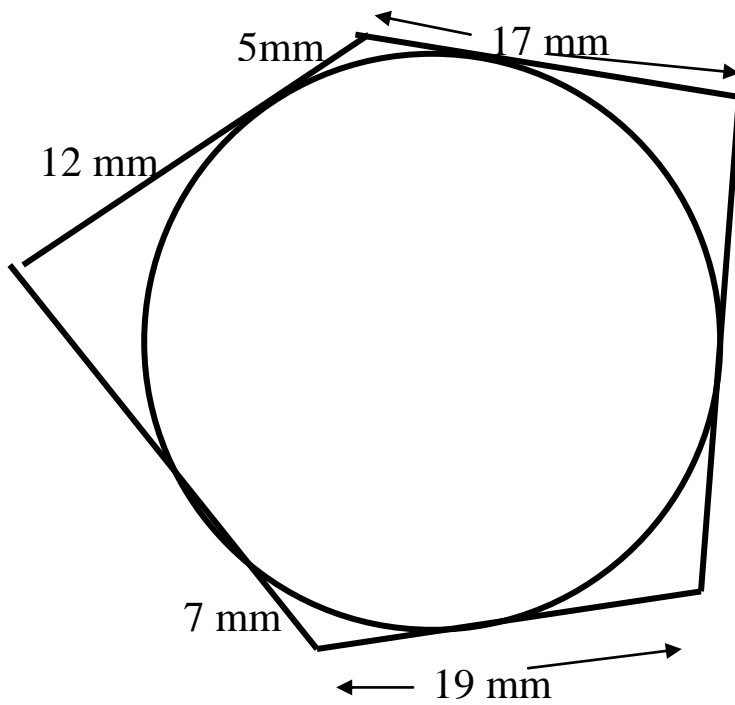

40

Find x

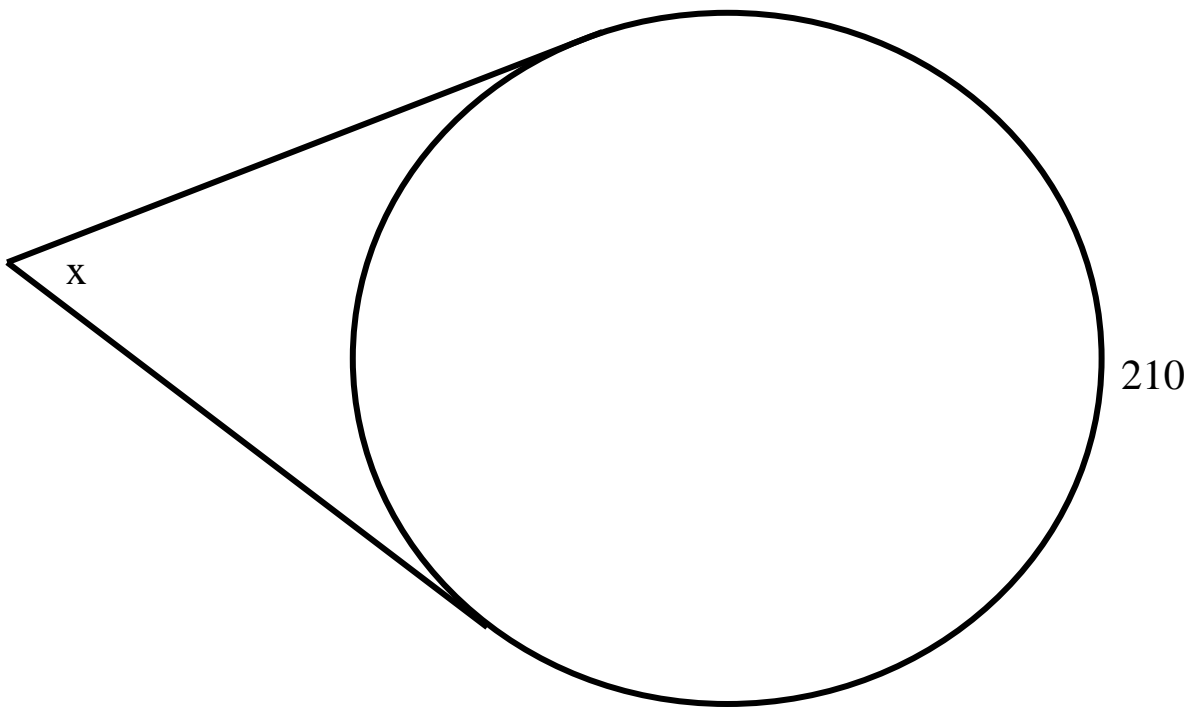

96

Find x

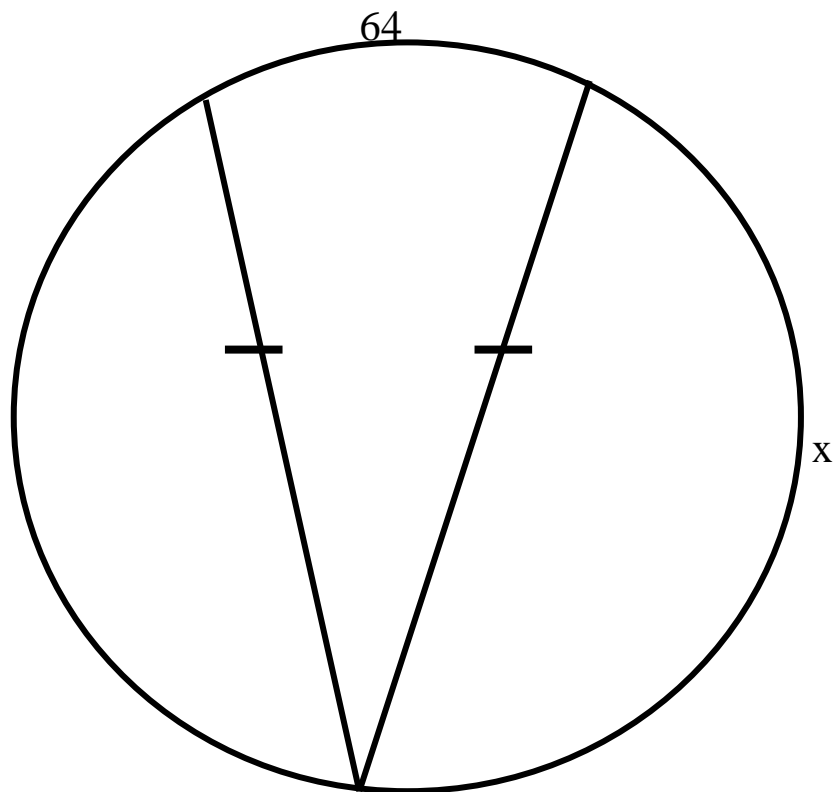

30

Find the radius, x

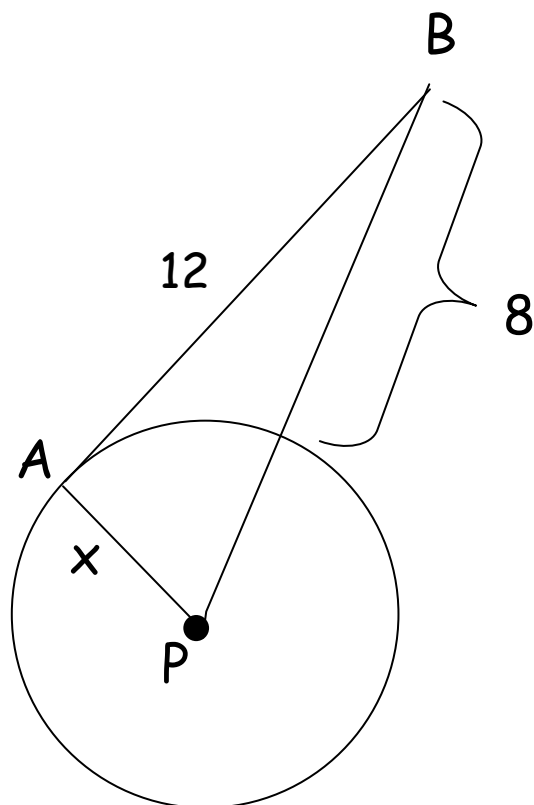

148

Find x

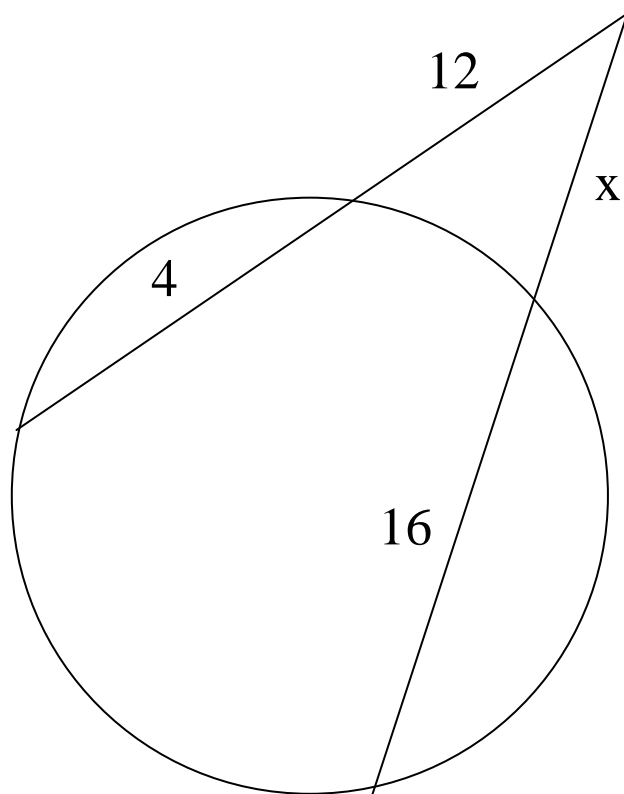

5

Find x

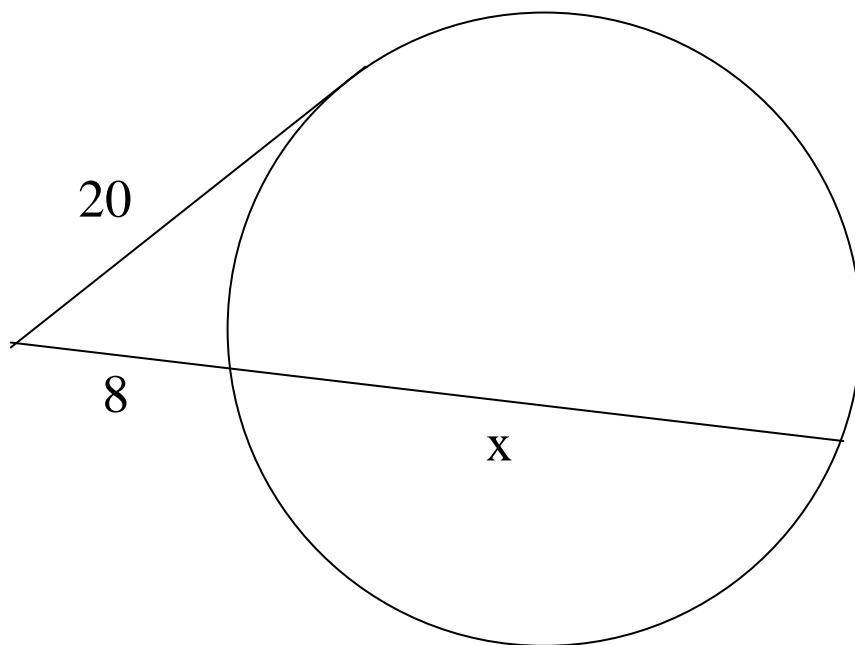

8

Find x

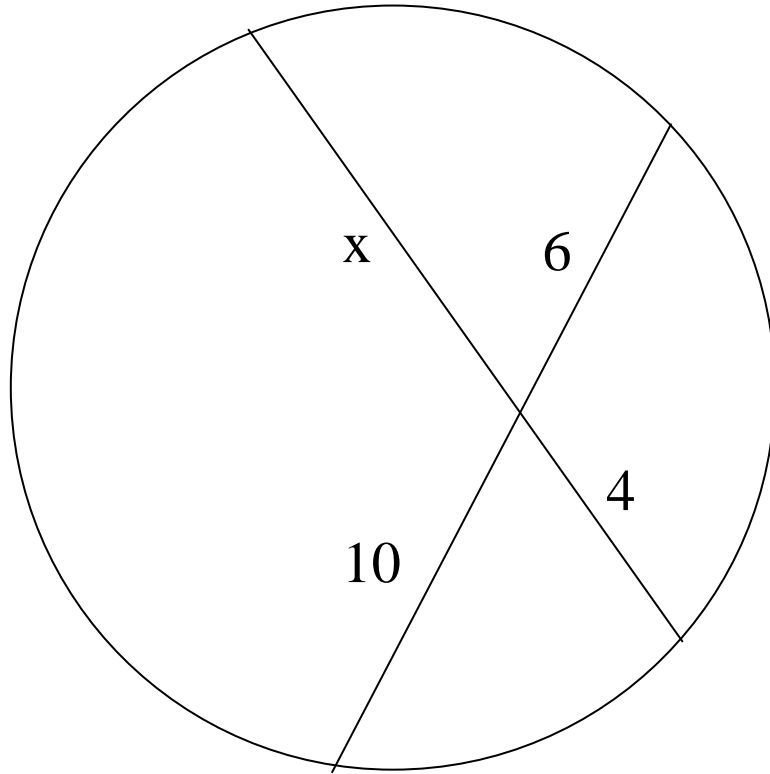

42

$x = \underline{\hspace{2cm}}$

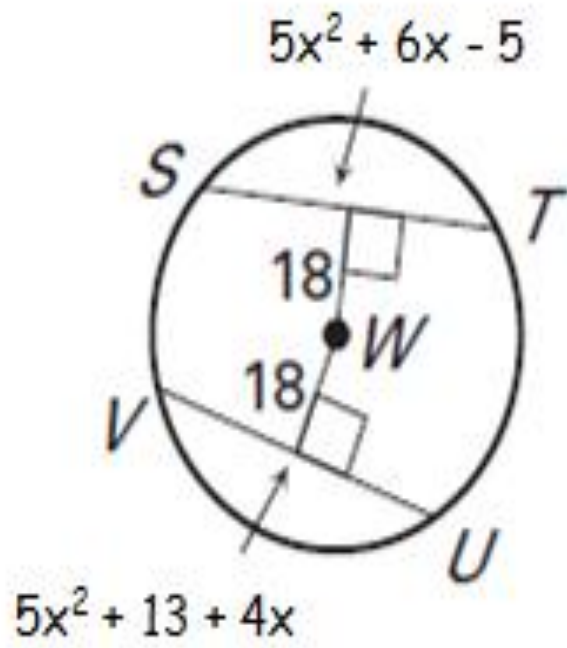

15